



FY16 Q3 Stakeholder Call

27 April 2016 | For quarter ending 31 March 2016

Agenda

- ⦿ **President's Overview (10 min)** - Akram Atallah
- ⦿ **Policy Update (10 min)** – Marika Konings & Adiel Akplogan
- ⦿ **Management Update (15 min)** – Theresa Swinehart
- ⦿ **Financial Update (10 min)** – Xavier Calvez
- ⦿ **Q&A (30 min)** - All

A world map where the continents are defined by a network of white dots and lines, resembling a social or data network. The background is a solid dark blue color.

President's Overview

Akram Atallah, President and CEO

Overview

- ⦿ FY16 Q3 for period ending 31 March 2016

Topics:

- Beta KPI Dashboard
- Operational performance and excellence
- Contractual Compliance
- Community support
- Internet Governance
- IANA Stewardship Transition
- Enhancing ICANN's Accountability

KPI Dashboard

Objectives & Overall Status

- ▶ **1** Evolve and further globalize ICANN
- ▶ **2** Support a healthy, stable and resilient unique identifier ecosystem
- ▶ **3** Advance organizational, technological and operational excellence
- ▶ **4** Promote ICANN's role and multistakeholder approach
- ▶ **5** Develop and implement a global public interest framework bounded by ICANN's mission

79

75

87

87

73

How to read and understand the charts:

0 - 49

Tracking significantly short of target
Immediate corrective action needed

50 - 84

Tracking short of target
Corrective actions as needed

85 - 100

Tracking to target
Stay the course, no corrective action needed

KPI Dashboard:

<https://www.icann.org/progress>

Operational Performance

FY16 Q3 HIGHLIGHTS

84 TLD strings delegated

5 Registry Agreements signed

1,860 total IANA Department Tickets

- FY17 Operating Plan and Budget and Five-Year Operating Plan – public comment process closes 30 April
 - <https://www.icann.org/news/announcement-2016-03-05-en>
- FY16 Q3 financial position: revenues were higher than budget and baseline expenses were lower than budget, offsetting higher transition related costs
- First version of the Root Zone Label Generation Ruleset released for Arabic script
- EFQM Excellence Model progress- conducted internal assessment and working towards external assessment in FY18

Contractual Compliance



REGISTRAR

2013 RAA

NEAR COMPLETION

86%

Completed remediation and received final audit reports



REGISTRY

2016 REGISTRY AGREEMENT AUDIT

AUDIT PHASE

10

Registry operators In scope

ANNUAL COMPLIANCE CERTIFICATION



229

Inquiries

220

Resolved/Closed*



308

Inquiries

303

Resolved/Closed*

* As of Q3

ENGAGEMENT & OUTREACH IN CHINA



- ⦿ 160 Registry & Registrar representatives
- ⦿ **Topics:** Abuse, WHOIS, Inaccuracy, WHOIS format, registration transfers, dispute resolutions

WHY IT'S IMPORTANT

ICANN operates in a bottom-up, multistakeholder model.

ICANN is committed to offering the tools, resources and programs to help this community do its important work.

- ⦿ ICANN Stakeholder Journey framework
- ⦿ NextGen@ICANN- 27 attended at ICANN55
- ⦿ Fellowship Program – 38 fellows at ICANN55
- ⦿ Community Mentor Pilot launched at ICANN55
- ⦿ [ICANN Learn](#)- 919 new users since we rolled out the upgraded platform in October

Internet Governance

WHY IT'S IMPORTANT

ICANN is one participant of many in the Internet governance ecosystem, and participates because it is committed to maintaining a single stable open and interoperable Internet.

Moving Forward: ICANN is planning to participate in the following events with the CCWG IG and in cooperation with sister technical organizations:

- **World Summit on the Information Society (WSIS) Forum** in Geneva in May
- **Committee on Science Technology and Development (CSTD)** in Geneva in May
- **Economic and Social Council (ECOSOC)** multistakeholder discussion forum at the UN in June
- **Organization for Economic Cooperation and Development (OECD)** Ministerial meeting in Mexico in June
- **ITU - World Telecommunication Standardization Assembly (WTSA)** in Tunisia in October
- **Internet Governance Forum (IGF) 2016** in Guadalajara, Mexico in December
 - In addition to continued support for and participation in National and Regional IGFs such as EUROdig; APriIGF; SEEDIG and others

Developing the Proposals

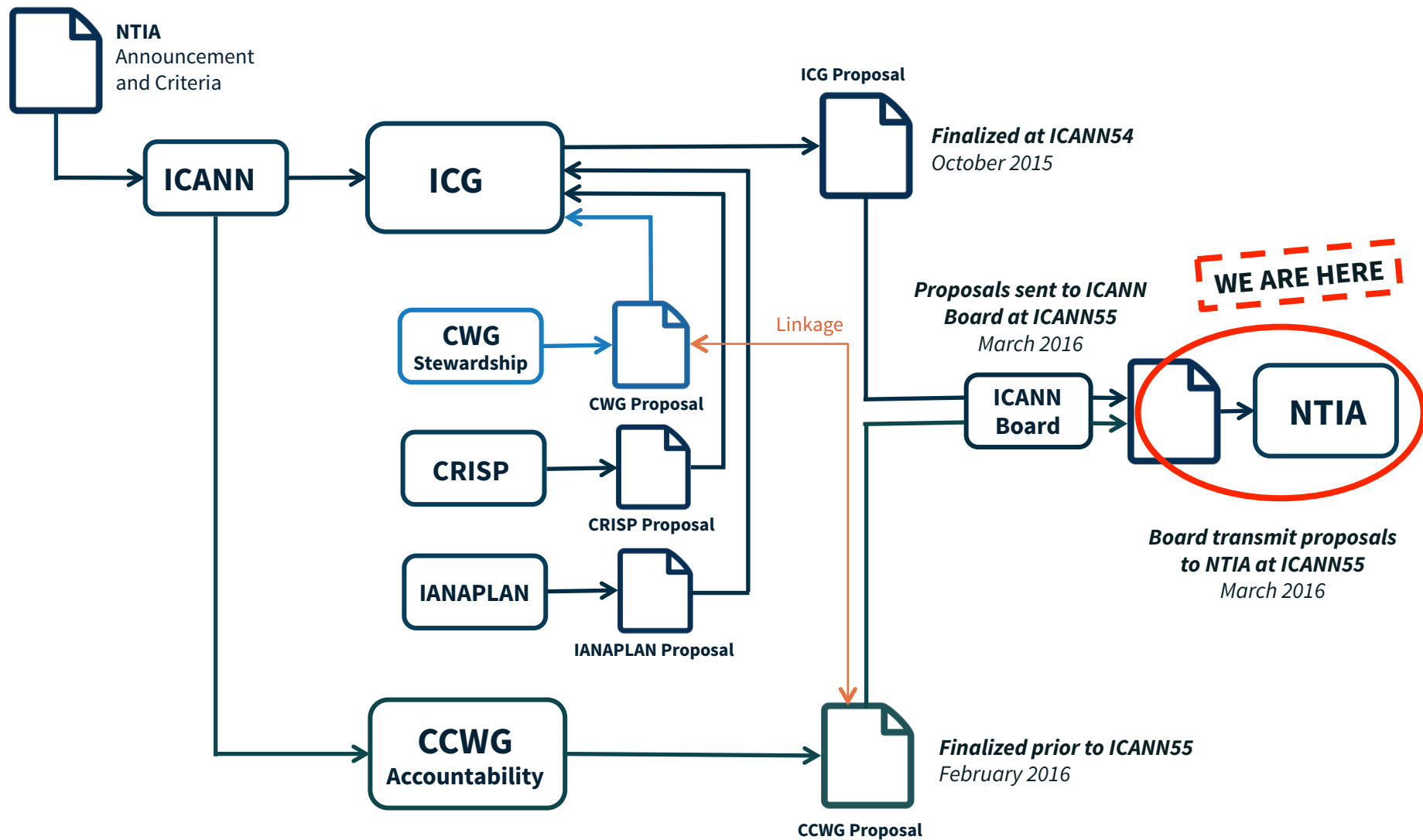

An Unprecedented Multistakeholder Effort

MAJOR WORKING GROUP EFFORTS



800+

Working Hours in Meetings



33,100+

Total Mailing List Exchanges



600+

Total Calls/Meetings

A SUPPORTING GLOBAL DISCUSSION

More than **1,100**

* 590+ Webinars

Events around the world where the IANA transition was discussed, debated, organized and planned

Between March 2014 and March 2016



ICG + CCWG ACCOUNTABILITY

ICG

30
Members

Number Resources
CRISP Team

15
Members
= 3 Members x 5 RIRs

Protocol Parameters
IANAPLAN

2,250
Mailing List Exchanges

Domain Names
CWG-Stewardship

153
Members & Participants

152
Calls and Meetings

CCWG-Accountability

203
Total Participants

28 Members
175 Participants

111
Mailing List Observers

REGIONAL REPRESENTATION



* 48 countries are represented by members/participants of the CCWG-Accountability

ORGANIZATIONAL STAKEHOLDER REPRESENTATION



THE TWO PARALLEL PROCESSES

IANA Stewardship Transition

Enhancing ICANN Accountability for the Transition

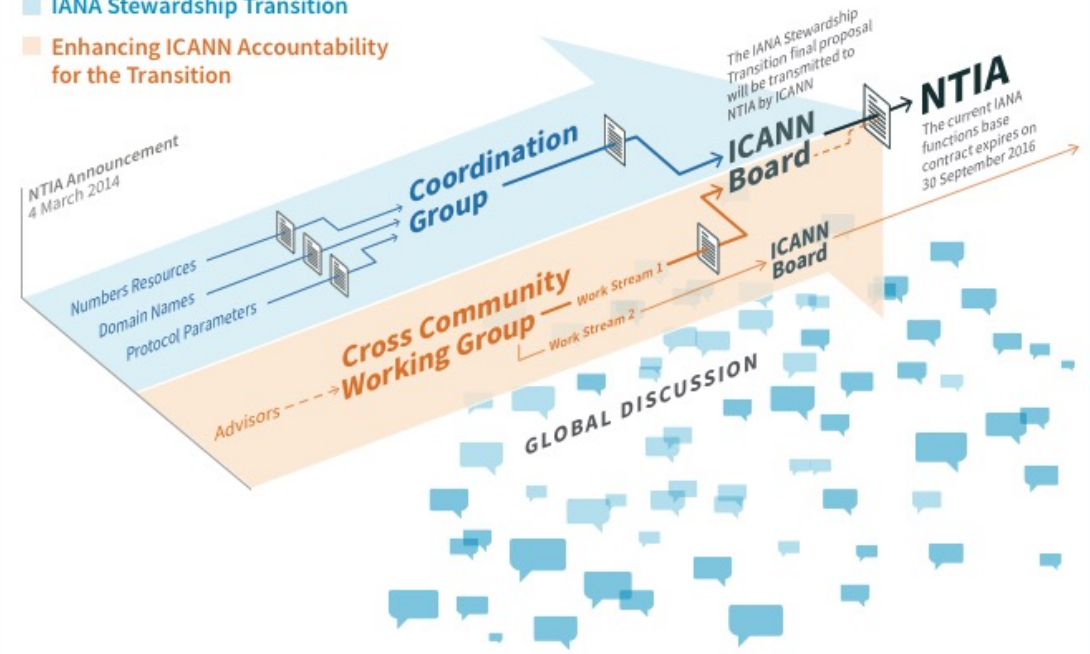

A Look Ahead: Phases 2 and 3

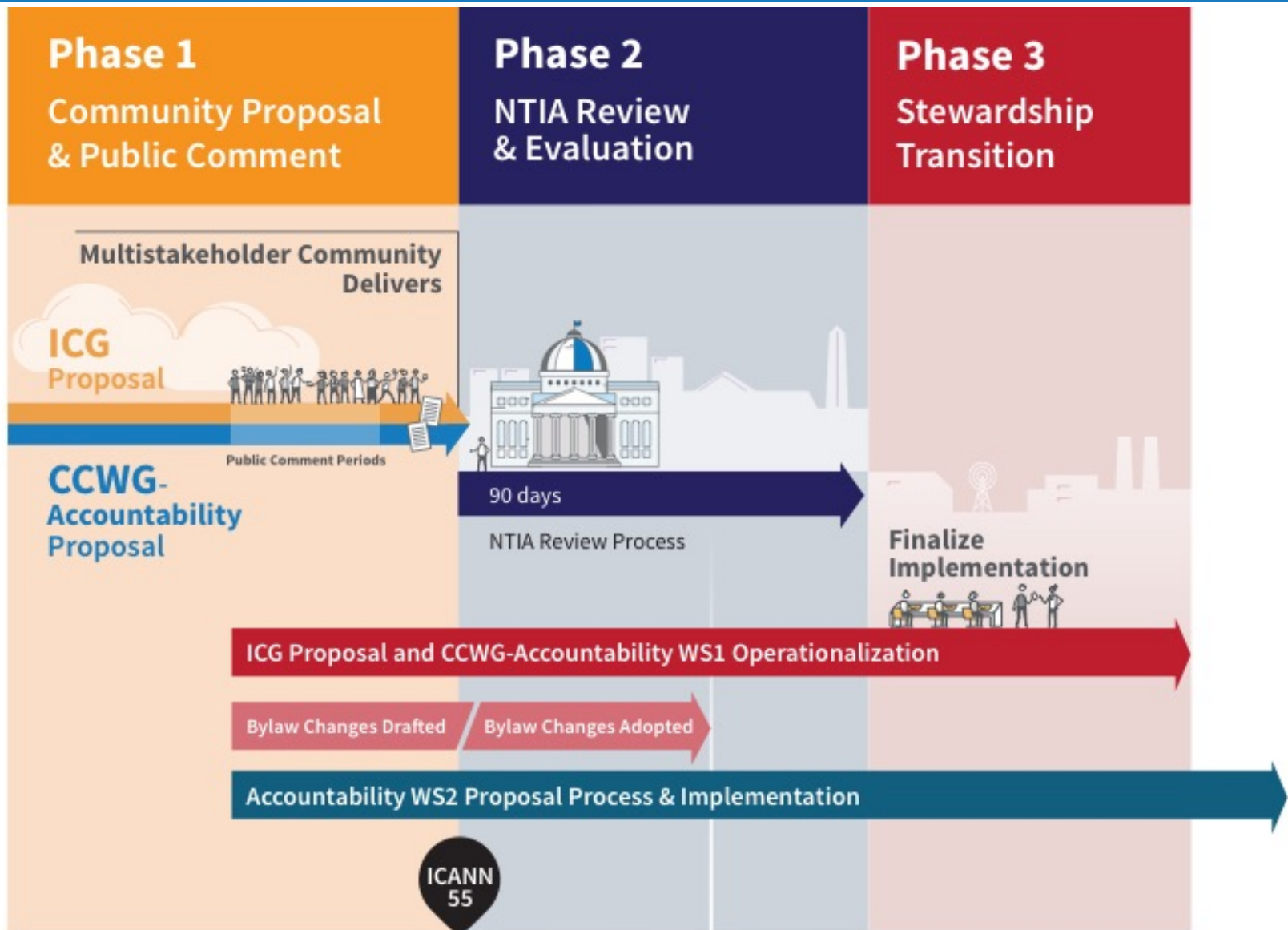

Transition Implementation Reporting



Follow updates on Implementation:
<https://www.icann.org/stewardship-implementation>



GET STARTED

NEWS & MEDIA

POLICY

PUBLIC COMMENT

RESOURCES

COMMUNITY

IANA STEWARDSHIP
& ACCOUNTABILITY

Implementation

IANA Stewardship Transition Implementation

ICANN's objective for implementation of the IANA Stewardship Transition is to be as open and transparent as possible, and to work with the community from the outset of implementation to make sure the transition happens in a timely manner while respecting the IANA contract obligations.

1

Latest Updates & Blog

2

Meetings & Work Sessions

3

Document Archive & Links

Latest Updates & Blog

Be informed of the latest news and blog about the Implementation work

Meetings & Work Sessions

Get access to the future meeting schedule and the past meeting archives

Document Archive & Links

Download any documents related to the implementation work



Policy Update

Marika Konings, Sr. Policy Director &
Team Leader for GNSO

&

Adiel Akplogan, VP Technical
Engagement

Generic Names Supporting Org. (GNSO)

FY16 Q3 HIGHLIGHTS

8 motions adopted

12 Policy Development processes underway

65 GNSO sessions held during ICANN 55

MORE INFORMATION

<https://www.icann.org/policy>

<http://gnso.icann.org/en/>

New areas of work in Q3

- ⦿ Adoption of PDP Working Group Charter on new gTLD Subsequent Procedures
- ⦿ Initiation of Policy Development Process (PDP) on Review of All Rights Protection Mechanisms (RPMs) in all Generic Top-Level Domains (gTLDs)
- ⦿ Adoption of PDP Working Group Charter on Review of All Rights Protection Mechanisms (RPMs) in all Generic Top-Level Domains (gTLDs)
- ⦿ Drafting Team to develop a proposed charter for a Cross-Community Working Group on new gTLD Auction Proceeds

Completed work in Q3

- ⦿ Adoption of CCWG-Accountability Supplemental Final Proposal on Work Stream 1 Recommendations
- ⦿ Adoption of Privacy and Proxy Services Accreditation Issues Policy Development Process Final Report

Country-Code Names Supporting Org. (ccNSO)

FY16 Q3 HIGHLIGHTS

5 cross-community working groups (chartering organization)

6 active ccNSO working groups

22 Council decisions

2 standing Council committees

20+ sessions at ICANN 56

MORE INFORMATION

<https://www.icann.org/policy>

<http://ccnso.icann.org/>

- Focus on IANA Stewardship Transition and ICANN Accountability: ccTLD community present in Marrakesh and ccNSO Council broadly supported CCWG-Accountability.
- The ccNSO Council mandated the Guideline review Committee to develop processes and procedures to meet the ccNSO specific requirement flowing from CWG-Stewardship and CCWG-Accountability Proposals.
- ccNSO Council 7 updated internal ccNSO Guidelines to meet the changing demands on ccNSO and its Council
- ccTLD community started discussion on ccNSO policy development processes on retirement of ccTLDs and review mechanism for decision pertaining to delegation, revocation and retirement of ccTLDs. Launch of PDP expected in June 2016

Number Resource Org. (NRO) & Address Supporting Org. (ASO)

- ◉ Election process started 30 September 2015 for ICANN Board Seat 10 (seat currently held by Kuo-Wei Wu). Four candidates have been interviewed.
- ◉ ASO Advisory Council is currently making updates to the election procedures so these are aligned with current ICANN Bylaws.
 - ◉ <https://aso.icann.org/aso-icann/icann-board-elections/2016-elections/>
- ◉ ASO Approval to CCWG Final Report
 - ◉ <https://www.nro.net/news/aso-approval-to-ccwg-final-report>
- ◉ NRO currently in discussion with other Operational Communities on IANA IPR
- ◉ RIR mailing list and policy development participation
 - ◉ <https://www.nro.net/policies>



Number Resource Org. (NRO) & Address Supporting Org. (ASO)

- ⦿ RIR-ICANN Service Level Agreement (Final version, 5.1 currently in negotiations with ICANN)
 - ⦿ <https://www.nro.net/sla>
- ⦿ All Service Level Agreement (SLA) processes and discussions documented at
 - ⦿ <https://www.nro.net/iana-oversight>

Next RIR Meetings:

AFRINIC 24- Gaborone, Botswana- 6-10 June 2016

APNIC42- Dhaka, Bangladesh 29 September -6 October 2016

ARIN 38 – Dallas USA 20-21 October 2016

LACNIC 26- San Jose, Costa Rica 26-30 September 2016

RIPE 73 Madrid, Spain 24-28 October 2016



The background of the slide is a solid orange color. Overlaid on this is a stylized world map. The map is formed by a network of small white dots connected by thin white lines, creating a mesh-like structure that outlines the continents. The dots are of varying sizes, and the lines are thin and light-colored.

Management Update

Theresa Swinehart, Sr. VP,
Multistakeholder Strategy and
Strategic Initiatives

Executive Summary

- ⦿ Information Technology & Internet Technology update
- ⦿ Global Domains Division (GDD) update
- ⦿ Contractual Compliance metrics
- ⦿ Global stakeholder engagement metrics

Information Technology Update

1

Application & Identity
Management

2

Web Content
Management System &
Document Management
System

Internet Technology / Office of CTO Update

WHY IT'S IMPORTANT

Maintaining the security, stability and resiliency of the Internet is a core part of ICANN's mission, and fundamental to the Internet and ICANN's work.

- ⦿ Continuing and prioritizing work on DNSSEC Key Signing Key (KSK) roll over plan for the root zone
- ⦿ Preparing for second Security, Stability, and Resiliency (SSR) review as mandated in ICANN's Affirmation of Commitments
- ⦿ Ongoing research on DNS related activity such as: middlebox and recursive resolver testing, analyzing anomalies in DNS traffic to authoritative servers, and exploring various instances of DNS abuse
- ⦿ Identifier Technologies Health Indicators project commenced at ICANN55; collaboration with the multi-stakeholder community to develop indicators of Internet health
- ⦿ Participated in anti-abuse and other security, stability and resiliency training and engagement sessions around the world

FY16 Q3 Contractual Compliance



Total Volume	Jan-16	Feb-16	Mar-16	Q3 Total	Q2 Total
Total New	3,326	3,996	3,449	10,771	11,749
Total Closed	3,905	3,820	3,929	11,654	11,322

Closure Rates	Jan-16	Feb-16	Mar-16	Q3 Average	Q2 Average
New Tickets	57%	59%	69%	62%	58.67%
All Tickets [Target >= 55%]	72%	69%	76%	72%	70%

Turnaround Time (days)	Jan-16	Feb-16	Mar-16	Q3 Average	Q2 Average
Received-to-Closed	12.2	10.3	9.6	10.7	9.5

Contractual Compliance Monthly Dashboard at: <https://features.icann.org/compliance>

Beta ICANN KPI Dashboard at: <https://www.icann.org/progress>

GDD: New gTLD Program

*as of 31 March 2016

WHY IT'S IMPORTANT

The New gTLD Program is driving the largest expansion of the Domain Name System ever. Hundreds of new top-level domain names are being introduced into the Internet on a rolling basis.

The New gTLD Program is meant to enhance competition, innovation and choice.

84

Strings delegated
in FY16 Q3

955 total*

5

Registry Agreements
signed in FY16 Q3

1,223 total*

3

Contention sets
resolved in FY16 Q3

214 of 233 total*

New gTLD Program Reviews Updates

- ⦿ Initiated independent review of Trademark Clearinghouse and Competition, Trust and Choice review team discussions
- ⦿ Held an online discussion and issued draft of “New gTLD Program Safeguards to Mitigate DNS Abuse”
- ⦿ Published a revised version of the New gTLD Program Implementation Review
- ⦿ Summary of public comments on Continuous Data-driven Analysis of Root Server System Stability (CDAR) Study

WHY IT'S IMPORTANT

IDNs at the top-level enable Internet users to access domain names in their respective languages and scripts.

IDN ccTLDs allow countries and territories to represent their respective names scripts other than US-ASCII characters.

Internationalized Domain Names Program

- ⦿ First version of the Label Generation Ruleset (LGR-1) supporting Arabic script is now available
- ⦿ Korean Generation Panel became active

Country Code TLD Fast Track Process

- ⦿ Total of 49 IDN ccTLDs, representing 39 countries / territories evaluated*
 - ⦿ Bulgarian IDN ccTLD passed during the quarter
- ⦿ Total of 43 IDN ccTLDs delegated*

MORE INFORMATION: <https://www.icann.org/InternationalizedDomainNames>

GDD: Universal Acceptance of TLDs

WHY IT'S IMPORTANT

Universal Acceptance means that Internet applications and systems must treat all top-level domains (TLDs) in a consistent manner, including new gTLDs and internationalized TLDs. Specifically, they must accept, validate, store, process and display all domain names.



- ⦿ Quick guide for developers published
- ⦿ Conducted all-day workshop and public session at ICANN55 in Marrakech
- ⦿ Review of the most popular programming languages and browsers for UA readiness initiated.
- ⦿ UASG will soon be publishing *Introduction to UA Readiness* white paper

MORE INFORMATION: <https://www.icann.org/universalacceptance>
<https://community.icann.org/pages/viewpage.action?pageId=47255444>

GDD: IANA Department Tickets

542

Domain-
related
requests

1,002

Protocol-
related
requests

315

General
Inquiries

1 Number-
related event

1 Key signing
ceremony

1 January to 31 March 20156

GDD: Global Support Center Tickets

Case Volume Trending

Cases Created & Resolved

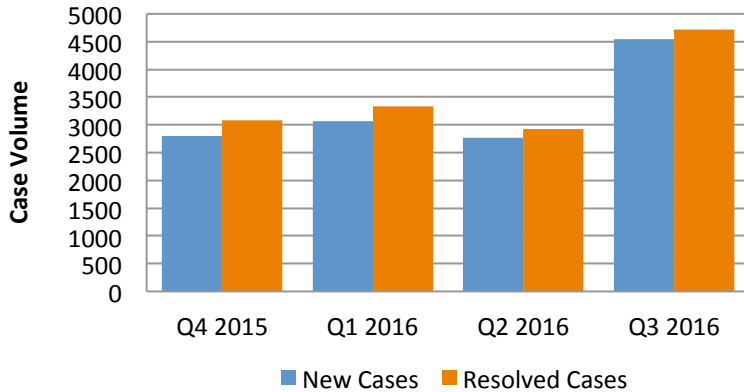

Case Backlog

Quarter End Volume Trending

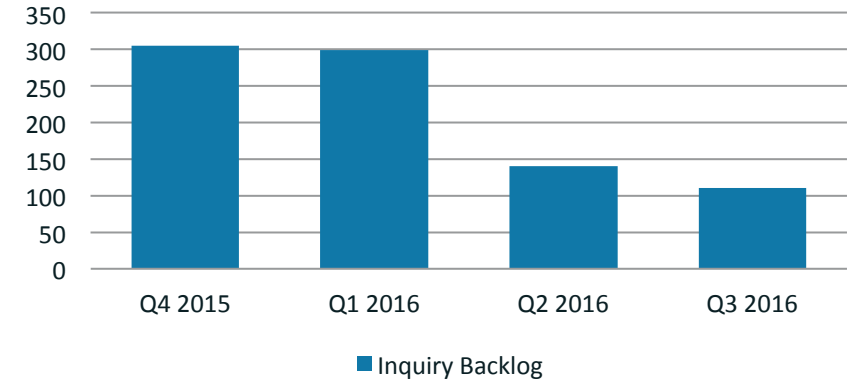

Status Frequency

Communication & Updates

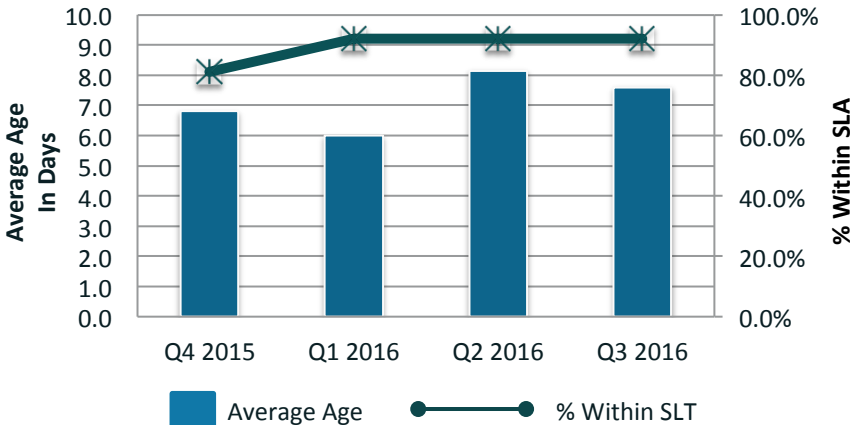

Resolution Time Target

Case Aging

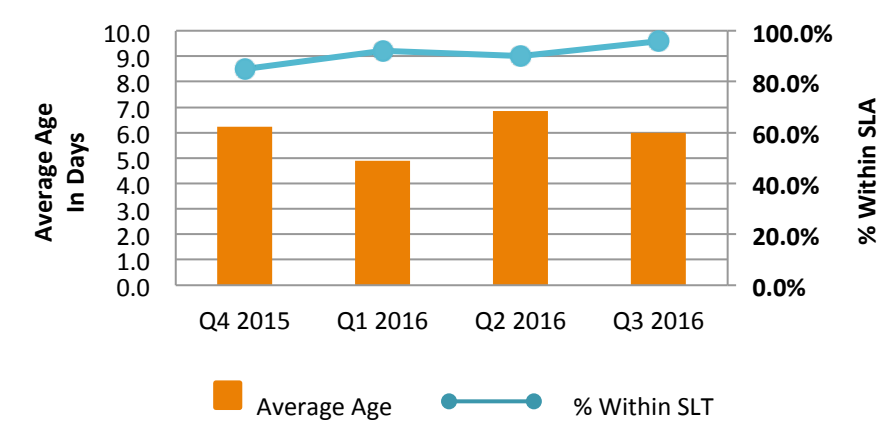

Engagement Events

FY16 Q1-Q3 total events: 397



159

EMEA

90

North America

78

Asia Pacific & Oceania

45

Latin America & Caribbean

20

Eastern Europe / Central Asia

MORE INFORMATION:

<https://community.icann.org/category/gse>

A world map where the continents are defined by a network of white dots and connecting lines, set against a dark blue background. The dots vary in size, and the lines are thin and light blue.

Financial Update

Xavier Calvez, CFO

Total ICANN Overview

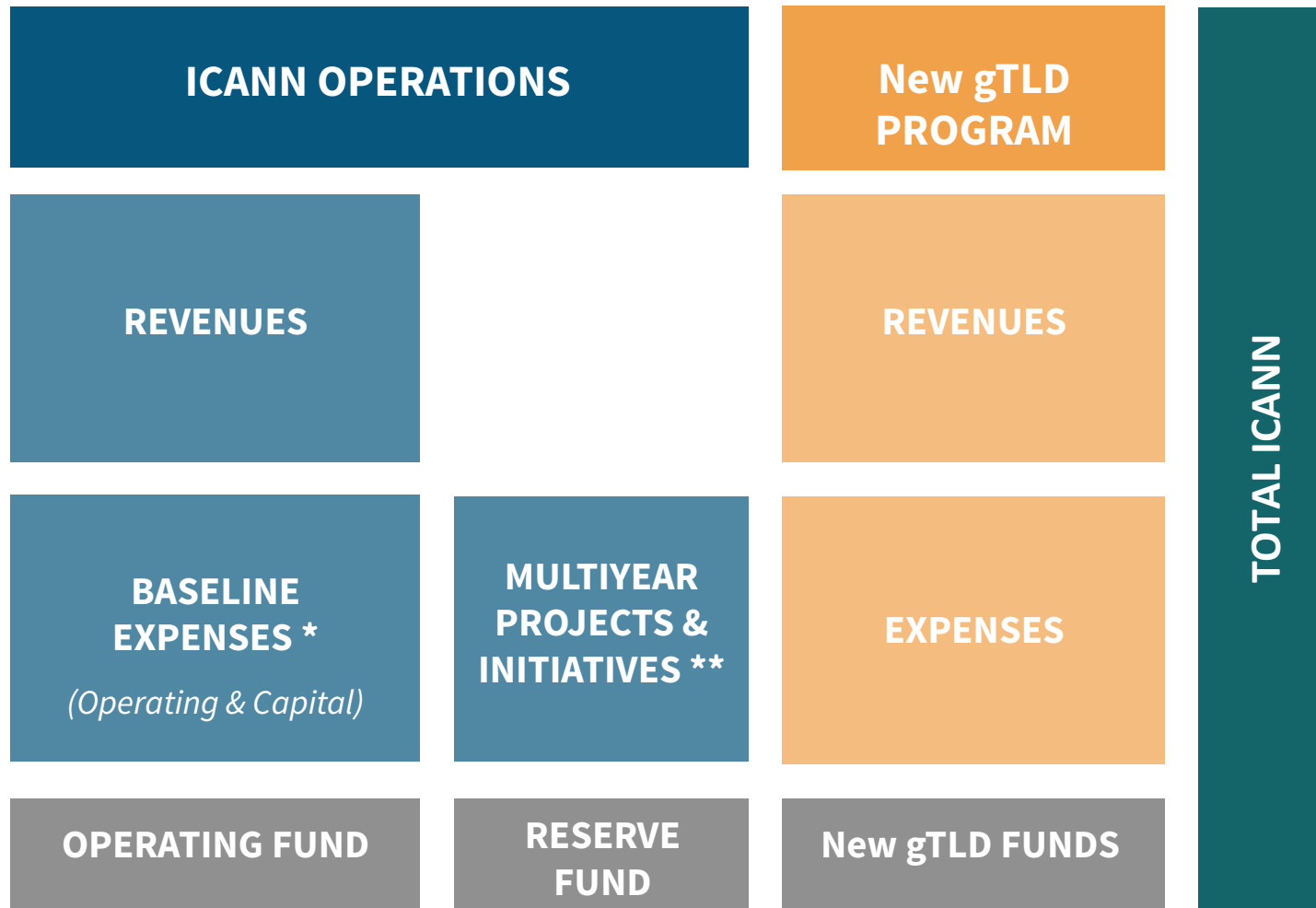

*: includes the IANA Operations

** includes the USG IANA Stewardship transition initiative

FY16 Year to Date Revenue

ICANN OPERATIONS

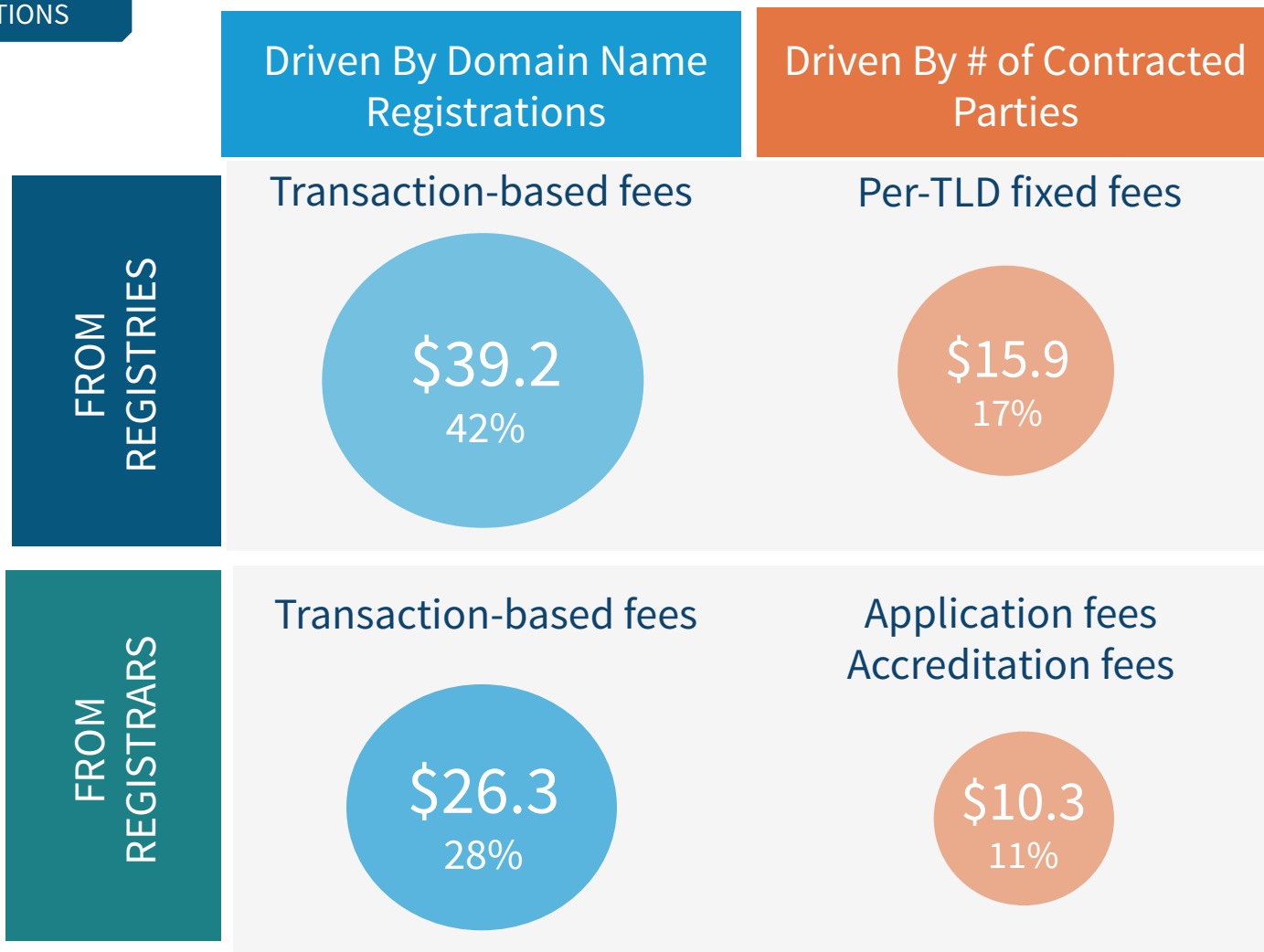

Other Income: \$1.5 (2%)

Total Support and Revenue: \$93.2

FY16 Year to Date Revenue vs Budget and Last Year

ICANN OPERATIONS

Revenue ahead of target.

Actual: \$ 93
Budget: \$ 83
Last Year: \$ 73



FY16 Year to Date Baseline Operating and Capital Expenses

ICANN OPERATIONS

**Total Year to Date
Baseline Operating &
Capital Expenses : \$ 74**

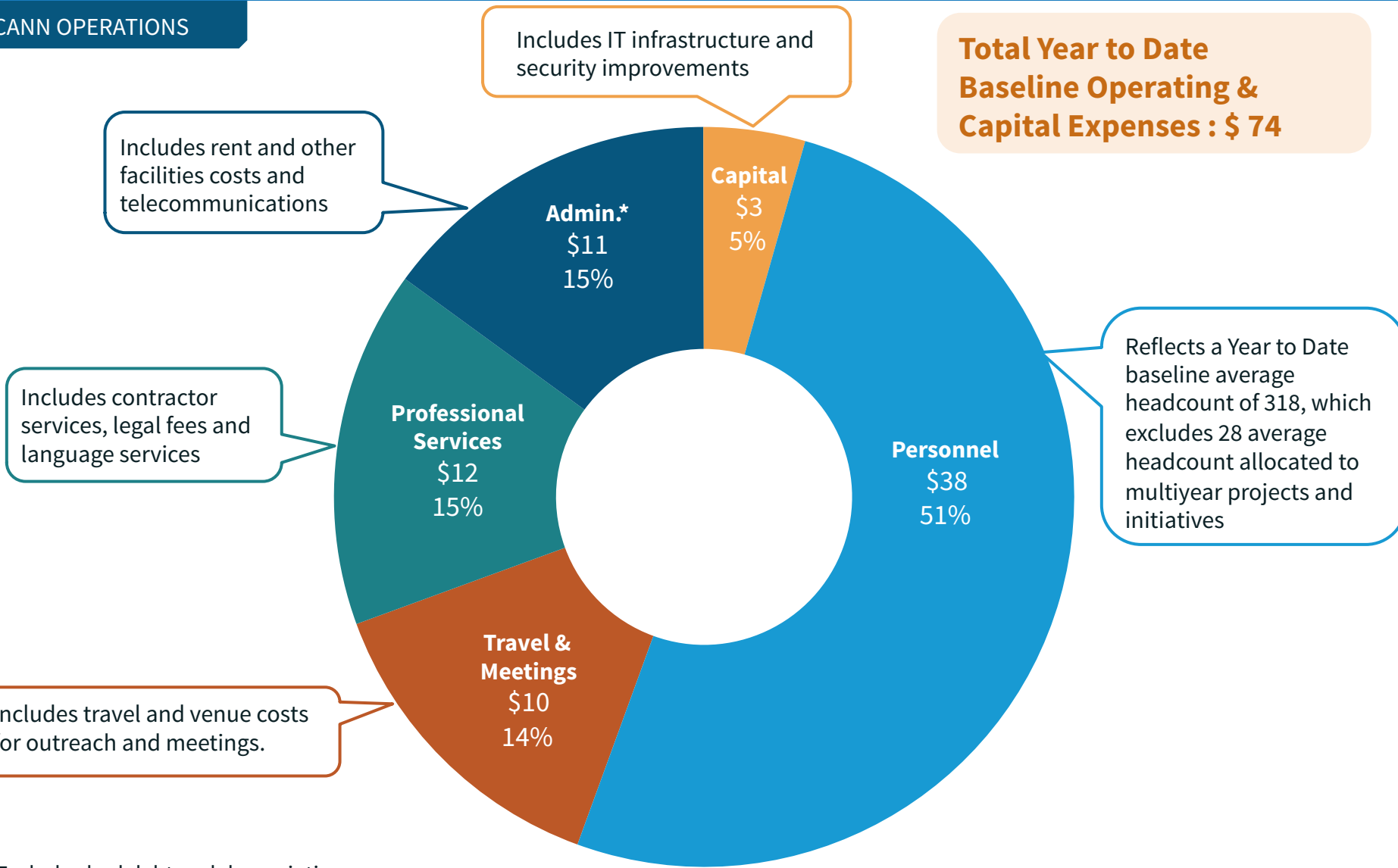

*Excludes bad debt and depreciation



FY16 Year to Date Baseline Operating Expenses and Capital vs Budget and Last Year

ICANN OPERATIONS

Timing differences of projects vs. plan.

Actual: \$ 74
Budget: \$ 85
Last Year: \$ 69

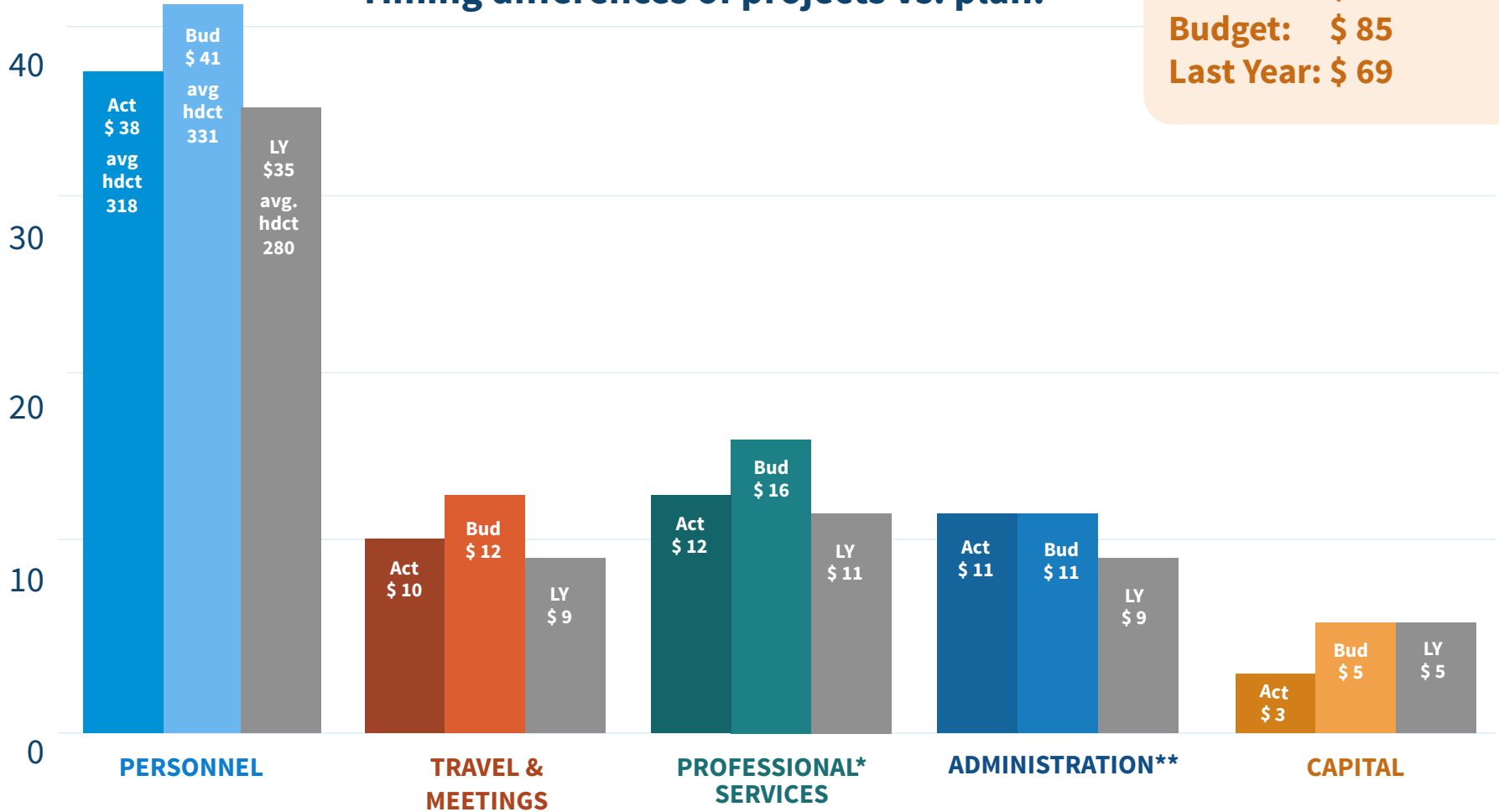

*Professional Services variance between actual and budget includes \$2M of unused contingency.

**Administration excludes bad debt and depreciation.



FY16 Multiyear Projects and Initiatives

ICANN OPERATIONS

	Year to Date Actual	Year to Date Budget	Var	FY16 Budget
USG Stewardship Transition	\$ 12.7	\$ 5.8	-\$ 6.9	\$ 6.9
Public Responsibility	\$ 1.4	\$ 2.1	\$ 0.7	\$ 2.5
Hardening Critical IT Infrastructure	\$ 1.2	\$ 1.9	\$ 0.7	\$ 2.5
New gTLD - Next Round Assessments & Preparation	\$ 0.0	\$ 0.4	\$ 0.4	\$ 0.5
Implementation of Reviews Recommendations	\$ 0.0	\$ 0.2	\$ 0.2	\$ 0.3
Total Initiatives	\$ 15.3	\$ 10.4	-\$ 4.9	\$ 12.8

In millions, USD- unaudited - Arithmetic inconsistencies are due to rounding to the nearest million.

FY16 Q3 | 36

FY16 Year to Date IANA Stewardship Transition Costs

ICANN OPERATIONS

**Total Year to Date
IANA Stewardship
Transition Costs: \$ 12.7**

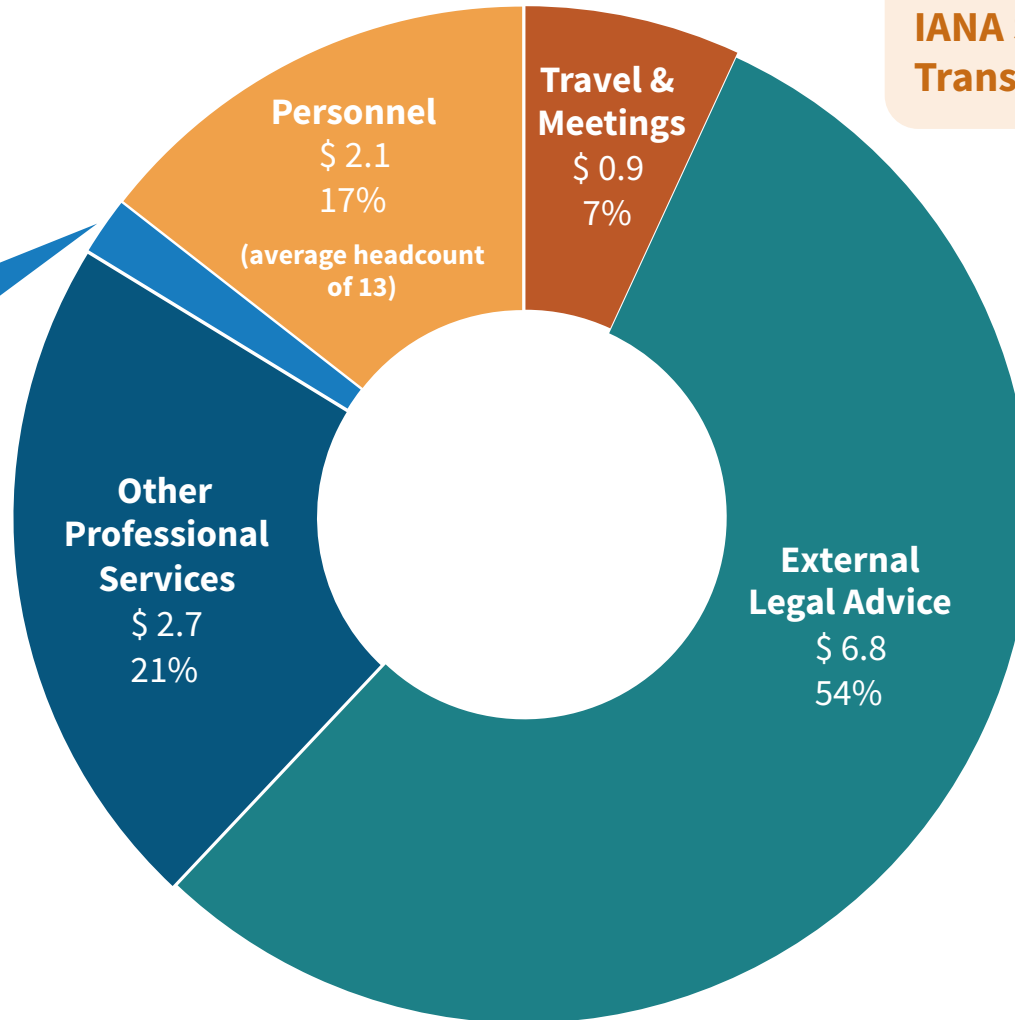

Administration

\$ 0.1
1%

**Other
Professional
Services**
\$ 2.7
21%

Personnel
\$ 2.1
17%
(average headcount
of 13)

**Travel &
Meetings**
\$ 0.9
7%

**External
Legal Advice**
\$ 6.8
54%

FY16 Year to Date Resource Utilization

ICANN OPERATIONS

Contribution to Reserve Fund Year to Date.
Revenue ahead of target.
Total expenses below target.

	Actual	Budget	Var	% Var	LY	Var	% Var
Support & Revenue	\$ 93	\$ 83	\$ 10	13%	\$ 73	\$ 20	28%
Baseline Expenses (Operating*/Capital)	-\$ 74	-\$ 85	\$ 11	13%	-\$ 69	-\$ 6	-8%
Multiyear Projects and Initiatives Expenses	-\$ 15	-\$ 10	-\$ 5	-44%	-\$ 3	-\$ 12	-420%
Net	\$ 4	-\$ 12	\$ 16	134%	\$ 2	\$ 2	139%

*Excludes bad debt and depreciation

New gTLD Program – Multi-year Forecast

New gTLD PROGRAM

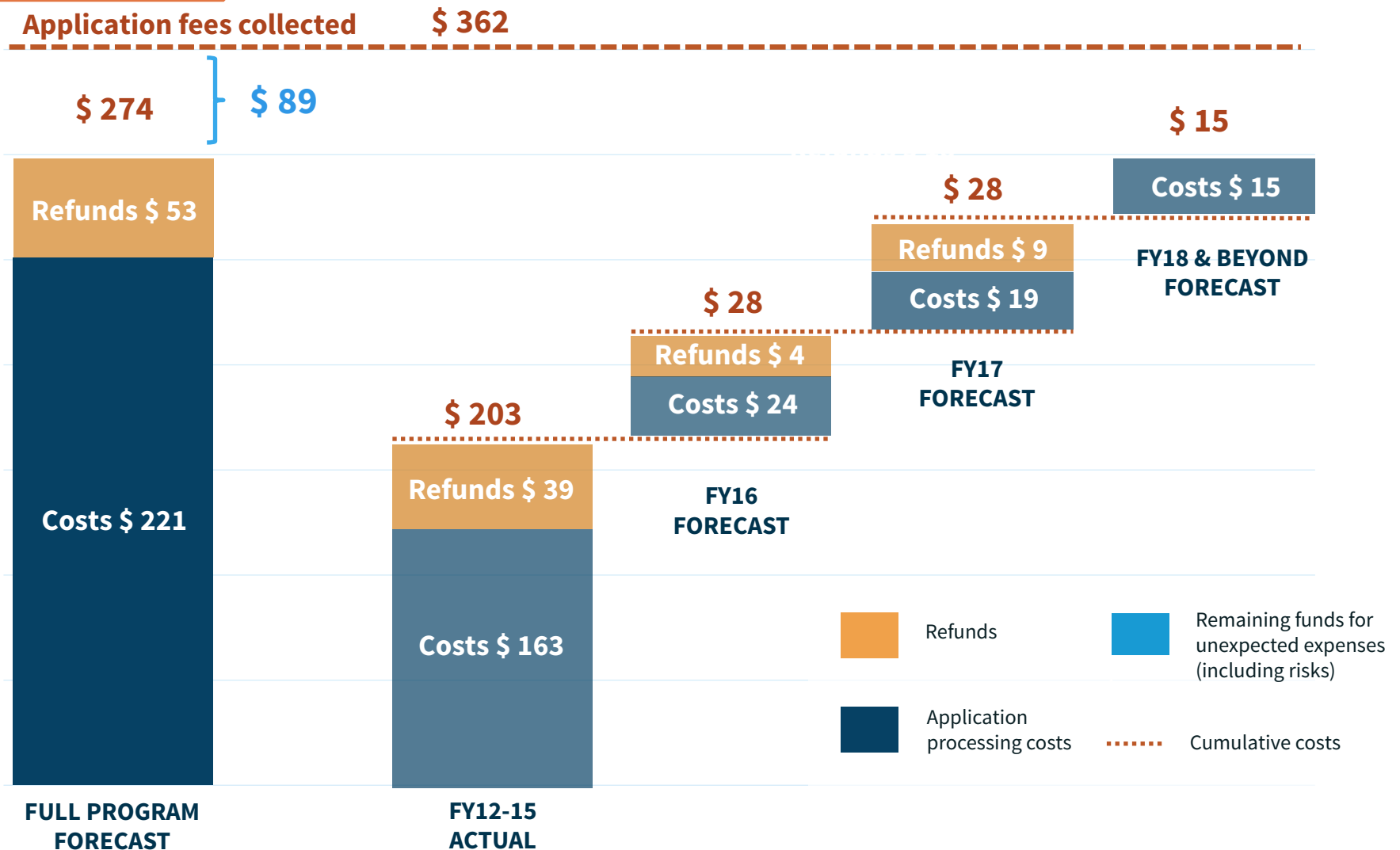

FY16 Year to Date New gTLD Program Costs

New gTLD PROGRAM

**Processing costs lower than target
driven by lower costs of
contracting activities.**

Actual: \$ 13
Budget: \$ 22
Last Year: \$ 26

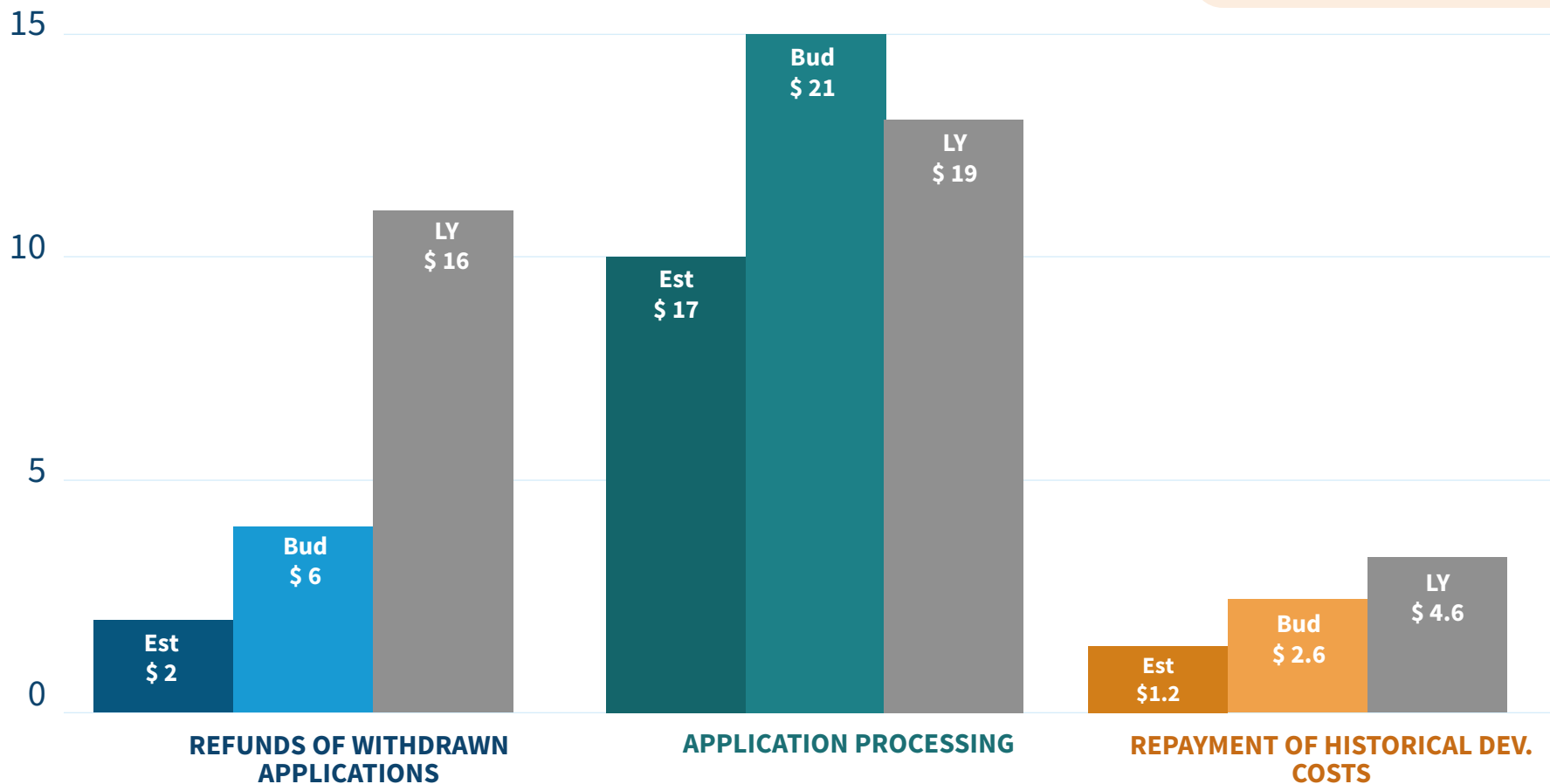

Funds Under Management

FUNDS UNDER MGMT.

New gTLD Program New gTLD funds/Auction proceeds

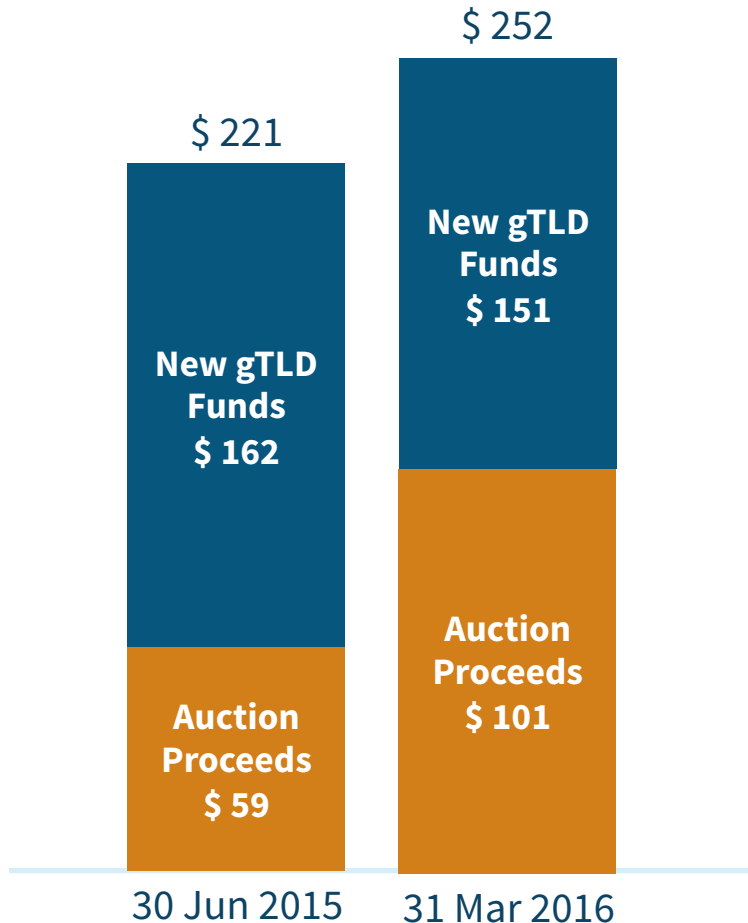

Total Funds: \$ 346
 Program-related: \$ 252
 ICANN Operations: \$ 93

ICANN Operations Operating and Reserve Funds

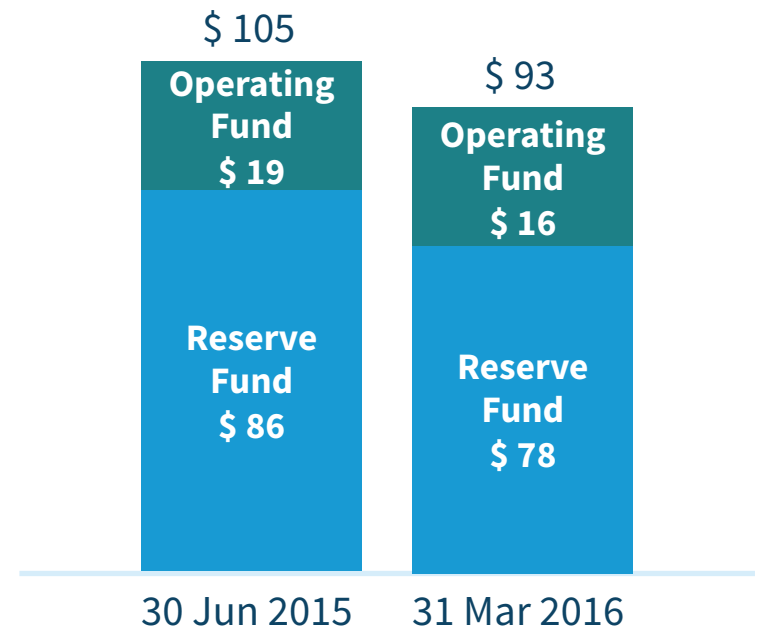

Thank You and Questions



SAVE THE DATE: FY16 Q3 CALL
18 August 1500 UTC

Email: icann.communications@icann.org

Website: <https://www.icann.org/resources/pages/quarterly-reports-2014-11-13-en>



twitter.com/icann



[gplus.to/icann](https://plus.google.com/icann)



facebook.com/icannorg



weibo.com/ICANNorg



linkedin.com/company/icann



flickr.com/photos/icann



youtube.com/user/icannnews



slideshare.net/icannpresentations